



COMFORT...BUILT TO LAST

6,000 BTU

WINDOW AIR CONDITIONER

USER MANUAL

FOR MODEL:

4PMC6000



Before using your window air conditioner, please read this manual carefully and keep it for future reference, along with your receipt.

CONTENTS

SAFETY PRECAUTIONS	2-3
IMPORTANT SAFETY INSTRUCTIONS	4
INSTALLATION INSTRUCTIONS	5-8
NORMAL SOUNDS	9
AIR CONDITIONER FEATURES	9-10
CARE AND CLEANING	11
TROUBLESHOOTING TIPS	12

This manual provides the information needed for proper use and maintenance of this air conditioner. Basic preventative care can help extend the life of this unit. The “Troubleshooting Tips” section in this manual contains a chart with solutions to the most common problems. Referring to this section may save time and prevent the need for a service call in the event of a problem.

CAUTION



- Contact an authorized service technician for repair or maintenance of this unit.
- Contact an installer for installation of this unit if necessary.
- ***The air conditioner is not intended for use by young children without supervision.***
Young children should be supervised to ensure that they do not play with the air conditioner.
- Disabled persons may require assistance with set up.
- If the power cord is to be replaced, replacement work should be performed by authorized personnel only using a cord from the product manufacturer.
- Installation and repair work must be performed in accordance with the national wiring standards by authorized personnel only.
- Do not operate your air conditioner in a wet room such as a bathroom or laundry room.

NOTE: *All the illustrations in this manual are for explanation purposes only. Unit purchased may be slightly different.*



The design and specifications are subject to change without prior notice for product improvement. Contact customer service for details.

SAFETY PRECAUTIONS

To prevent injury to the user or other people and property damage, the following instructions must be followed. Incorrect operation due to ignoring of instructions may cause harm or damage. The seriousness is classified by the following indications.

 WARNING	This symbol indicates the possibility of death or serious injury.
 CAUTION	This symbol indicates the possibility of injury or damage to property.

■ Meanings of symbols used in this manual are as shown below.

	Never do this.
	Always do this.

WARNING

 **Plug in power plug properly.**

● Failure to do so may cause electric shock or fire due to excess heat generation.

 **Do not operate or stop the unit by inserting or pulling out the power plug directly from the wall.**

● Doing so may cause electric shock or fire due to heat generation.

 **Do not use a damaged power cord.**

● Doing so may cause electric shock or fire. If the power cord is damaged, it must be replaced by the manufacturer or an authorized service center or a similarly qualified person in order to avoid a hazard.

 **Do not modify power cord length or share the outlet with other appliances.**

● Doing so may cause electric shock or fire due to heat generation.

 **Do not operate with wet hands or in damp environment.**

● Doing so may cause electric shock.

 **Do not direct airflow directly at room occupants.**

● This could cause health issues.

 **Always ensure effective grounding.**

● Incorrect grounding may cause electric shock.

 **Do not allow water to run into electric parts.**

● Doing so may cause failure of machine or electric shock.

 **Always install circuit breaker and a dedicated power circuit.**

● Incorrect installation may cause fire and electric shock.

 **Always unplug the unit if strange sounds, smell or smoke comes from the unit.**

● Failure to do so may cause fire and electric shock.

 **Do not use the socket if it is loose or damaged.**

● Doing so may cause fire and electric shock.

 **Do not open the unit during operation.**

● Doing so may cause electric shock.

 **Do not use firearms near unit.**

● Doing so may cause fire.

 **Do not use the power cord close to heating appliances.**

● Doing so may cause fire and electric shock.

 **Do not disassemble, modify, or drill holes into the air conditioner.**

● Doing so may cause failure and electric shock.

 **Ventilate room before operating air conditioner if there is a gas leak from another appliance such as a stove.**

● Failure to do so may cause explosion, fire and burns.

 **Do not use the power cord near flammable gas or combustibles, such as gasoline, benzene, thinner, etc.**

● Doing so may cause an explosion or fire.

SAFETY PRECAUTIONS (CONTINUED)

CAUTION

⊘ When removing air filter, do not touch metal parts of the unit.

- Doing so may cause an injury.

⚠ Unit and circuit breaker/fuse must be switched OFF when cleaning.

- Cleaning unit when power is ON may cause fire and electric shock and may cause an injury.

⚠ Stop operation and close the window in severe storms or hurricanes.

- Operation with windows open may cause moisture to enter the room.

⊘ Do not place obstacles around air-inlets or inside of air-outlet.

- Obstacles may cause appliance failure or accident.

⚠ Use only a soft cloth to clean the unit.

- Cleaners or detergents may change the color or scratch the surface of the unit.

⊘ Do not place heavy objects on the power cord and always ensure that the cord is not compressed.

- There is danger of fire or electric shock.

⊘ Do not clean with water.

- Water may enter the unit and degrade the insulation causing an electric shock.

⊘ Do not put a pet or house plant where it will be exposed to direct air flow.

- This could injure the pet or plant.

⚠ Hold the plug by the head of the power plug when taking it out.

- Failure to do so may cause electric shock and damage.

⚠ Periodically check installation bracket for damage.

- Prolonged exposure to outdoor elements may cause damage to installation bracket causing unit to fall.

⚠ Use caution when unpacking and installing.

- Sharp edges could cause injury.

⚠ If water enters the unit, turn the unit off at the power outlet and switch off the circuit breaker. Isolate supply by taking the power-plug out and contact a qualified serviced technician.

- There is danger of electric shock.

⚠ Ensure proper ventilation especially in rooms with a stove or other appliances.

- Failure to do so may result in an oxygen shortage.

⚠ Use only as intended.

- This unit is NOT intended to preserve precision devices, food, pets, plants, and art objects. It may cause deterioration of quality, etc.

⚠ If unit will not be used for a long period of time, turn OFF main power switch.

- Leaving power on may cause unit failure or fire.

⚠ Always insert the filters securely. Clean filter AT LEAST once every two weeks.

- Operation without secured filters may cause failure. A dirty filter can cause the unit to not run efficiently.

⊘ NEVER drink water drained from air conditioner.

- Water from unit contains contaminants and could cause illness.

IMPORTANT SAFETY INSTRUCTIONS

NOTE:

The power supply cord with this air conditioner contains a current detection device designed to reduce the risk of fire. Please refer to the section “Operation of Current Device” (below) for details. In the event that the power supply cord is damaged, it cannot be repaired. It must be replaced by an authorized repairman with a cord from the Product Manufacturer.

WARNING

Avoid fire hazards or electric shock. Do not use an extension cord or an adaptor plug. Do not remove any prong from the power cord.

Grounding type wall receptacle

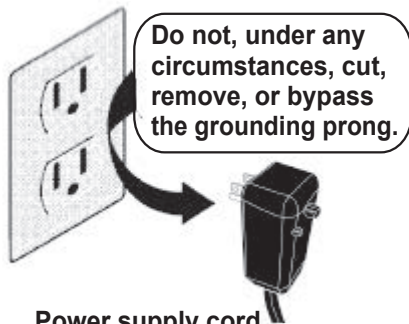

Power supply cord with 3-prong grounding plug and current detection device

Operation of Current Device

The power supply cord contains a current device that senses damage to the power cord. To test your power supply cord, do the following:

1. Plug in the air conditioner.
2. The power supply cord will have TWO buttons on the plug head. Press the TEST button. You will notice a click as the RESET button pops out.
3. Press the RESET button. Again, you will notice a click as the button engages.
4. The power supply cord is now supplying electricity to the unit. (On some products this is also indicated by a light on the plug head.)

WARNING

For Your Safety: Do not store or use gasoline or other flammable vapors and liquids in the vicinity of this or any other appliances.

WARNING

Prevent Accidents

- To reduce the risk of fire, electrical shock, or injury to persons when using your air conditioner, follow basic precautions, including the following:
- Be sure the electrical service is adequate for the model you have chosen. This information can be found on the serial plate, which is located on the side of the cabinet and behind the grille.
 - If the air conditioner is to be installed in a window, you will probably want to clean both sides of the glass first. If the window is a triple-track type with a screen panel included, remove the screen completely before installation.
 - Be sure the air conditioner has been securely and correctly installed according to the installation instructions in this manual.
 - Save this manual for possible future use in removing or installing this unit.
 - When handling the air conditioner, be careful to avoid cuts from sharp metal fins on front and rear coils.

WARNING

Electrical Information

- The complete electrical rating of your new room air conditioner is stated on the serial plate. Refer to the rating when checking the electrical requirements.
- Be sure the air conditioner is properly grounded. To minimize shock and fire hazards, proper grounding is important. The power cord is equipped with a three-prong grounding plug for protection against shock hazards.
 - Your air conditioner must be used in a properly grounded wall receptacle. If the wall receptacle you intent to use is not adequately grounded or protected by a time delay fuse or circuit breaker, have a qualified electrician install the proper receptacle.
 - Ensure the receptacle is accessible after the unit installation.
 - Do not run air conditioner without side protective cover in place. This could result in mechanical damage within the air conditioner.
 - **Do not use an extension cord or an adaptor plug.**

NOTE:

- Do not use this device to turn the unit on or off.
- Always make sure the RESET button is pushed in for correct operation.
- The power supply must be replaced if it fails reset when either the TEST button is pushed or it cannot be reset.
- If power supply cord is damaged, it cannot be repaired. Please call Consumer Services at 877-365-6274 to assist with replacement.

NOTE: This air conditioner is designed to be operated under the following conditions:

Cooling Operation	Outdoor temp:	64-109°F/18-43°C (64-125°F/18-52°C for special tropical models)
	Indoor temp:	62-90°F/17-32°C

Performance may be reduced outside of these operating temperatures.

INSTALLATION INSTRUCTIONS



BEFORE YOU BEGIN

Read these instructions completely and carefully.

IMPORTANT- Save these instructions.

IMPORTANT- Observe all governing codes and ordinances.

Note to Installer- Be sure to leave these instructions with the Consumer.

Note to Consumer- Keep these instructions for future reference.

Skill level- Installation of this appliance requires basic mechanical skills.

Completion time- Approximately 1 hour.

We recommend that two people install this product.

Proper installation is the responsibility of the installer.

Product failure due to improper installation is not covered under the Warranty.

You **MUST** use all supplied parts and use proper installation procedures as described in these instructions when installing this air conditioner.



WINDOW REQUIREMENTS

Your air conditioner is designed to install in standard double hung windows with opening widths of 23 to 36 inches (584 mm to 914 mm).

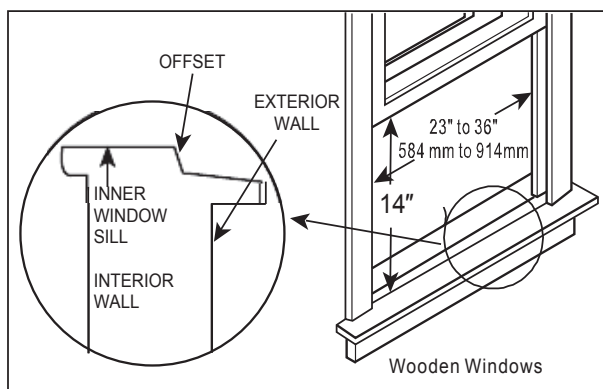

CAUTION

Do not, under any circumstances, cut or remove the third (ground) prong from the power cord.

Do not change the plug on the power cord of the air conditioner.

Aluminum house wiring may present special problems- consult a qualified electrician.

When handling unit, be careful to avoid cuts from sharp metal edges and aluminum fins on front and rear coils.

TOOLS YOU WILL NEED

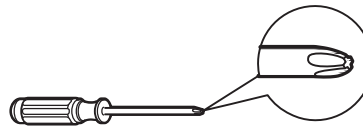

**Phillips
Screwdriver**



Level

TOOLS YOU MAY USE



Screwdriver



Pencil

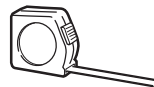

Ruler or tape measure

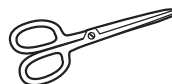

Scissors or knife

NOTE: Save carton and these Installation Instructions for future reference.
The carton is the best way to store unit during winter or when not in use.

INSTALLATION INSTRUCTIONS (CONTINUED)

1 PREPARE THE WINDOW

Lower sash must open sufficiently to allow a clear vertical opening of 14 inches. Side louvers and the rear of the AC must have clear air space to allow enough airflow through the condenser for heat removal. The rear of the unit must be outdoors, not inside a building or garage.

Mounting Hardware

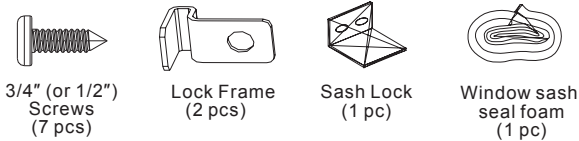

2 PREPARE AIR CONDITIONER

A: Remove the air conditioner from the carton and place on a flat surface.

B: Remove top rail from the rear of the packaging material as shown in Fig. A.

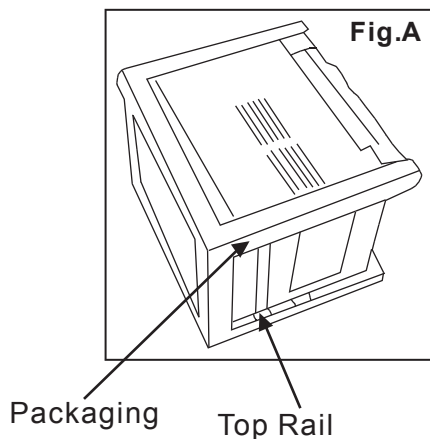
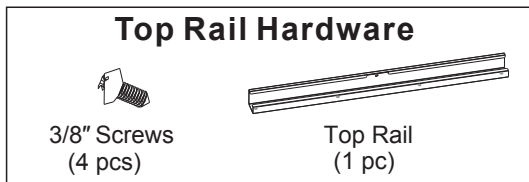

C: Align the hole in the top rail with those in the top of the unit as shown in Fig.B

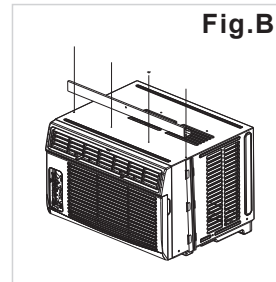

D: Secure the top rail to the unit with the 3/8" screws as shown in Fig.C.

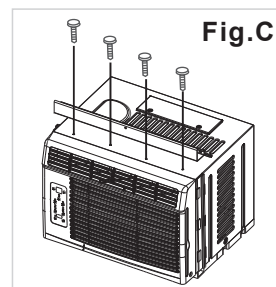

NOTE: For safety reasons, all four(4) screws MUST be securely fastened.

3 INSTALL THE ACCORDION PANELS

NOTE: Top rail and sliding panels on each side are offset to provide the proper pitch of 5/16" to the rear. This is necessary for proper condensed water utilization and drainage. If you are not using the side panels for any reason, this pitch to the rear must be maintained.

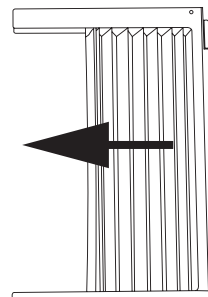

A. Place unit on floor, a bench or a table. Hold the accordion panel in one hand and gently pull back the center to fill the open end. See Fig.1.

INSTALLATION INSTRUCTIONS (CONTINUED)

- B. Slide the free end "I" section of the panel directly into the cabinet as shown in Fig. 2. Slide the panel down. Be sure to leave enough space to slip the top and bottom of the frame into the rails on the cabinet.

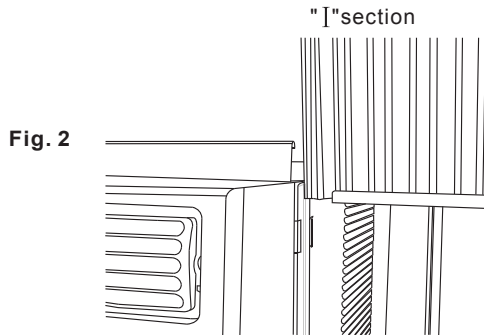

Fig. 2

- C. Once the panel has been installed on the side of the cabinet, make sure it sits securely inside the frame channel by making slight adjustments. Slide the top and bottom ends of the frame into the top and bottom rails of the cabinet. Fig. 3.

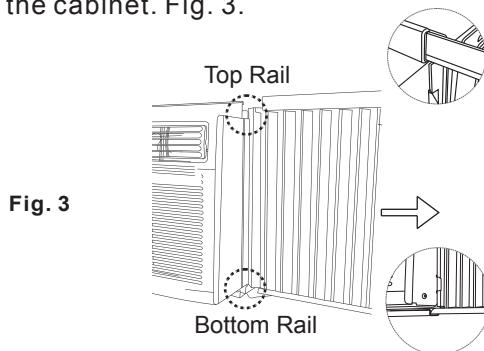

Fig. 3

- D. Slide the panel all the way in and repeat on the other side.

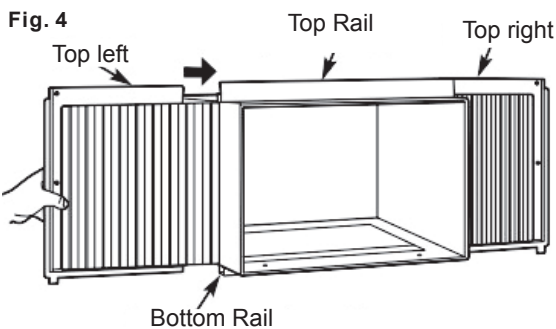
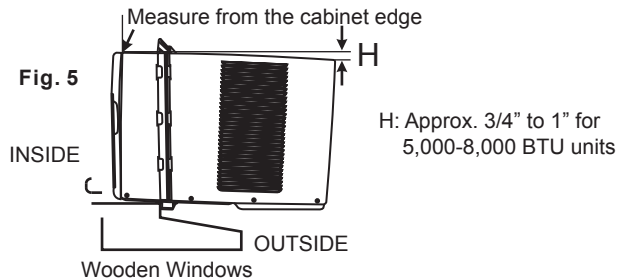

Fig. 4

NOTE: If storm window blocks AC, see Fig. 11.

4 SECURE THE ACCORDION PANELS

- A. Keeping a firm grip on the air conditioner, carefully place the unit into the window opening so the bottom of the air conditioner frame is against the window sill (Fig. 5). Carefully close the window behind the top rail of the unit.



NOTE: Check that air conditioner is tilted back approximately H (Fig. 5 above) (tilted about 3° to 4° downward to the outside). If, after proper installation, condensation does not drain from the overflow drain hole during normal use, adjust slope.

- B. Extend the side panels out against the window frame (Fig. 6).

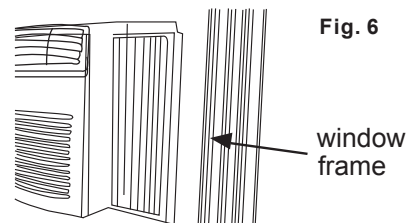

Fig. 6

5 INSTALL SUPPORT BRACKET

- A. Place the frame lock between the frame extensions and the window sill as shown in Fig. 7. Drive 3/4" (19 mm) or 1/2" (12.7 mm) locking screws through the frame lock and into the sill.

NOTE: To prevent window sill from splitting, drill 1/8" (3 mm) pilot holes before driving screws.

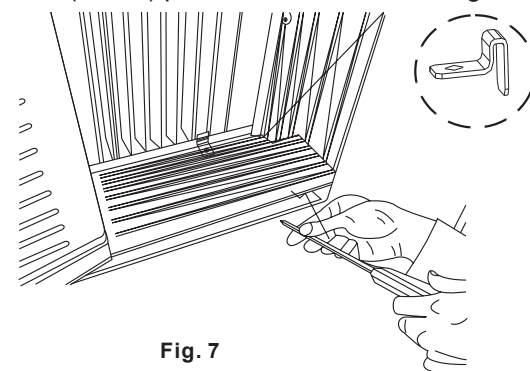

Fig. 7

INSTALLATION INSTRUCTIONS (CONTINUED)

B. Drive 3/4" (19 mm) or 1/2" (12.7 mm) locking screws through frame holes into window sash (Fig. 8).

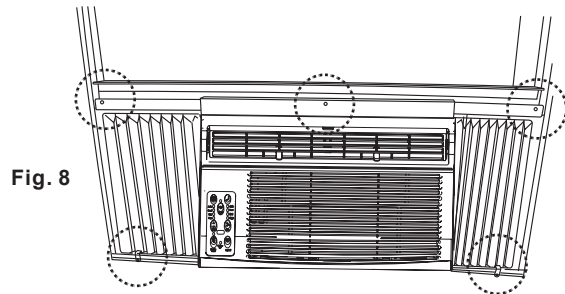

Fig. 8

C. To secure lower sash in place, attach right angle sash lock with 3/4" (19 mm) or 1/2" (12.7 mm) screw as shown (Fig. 9).

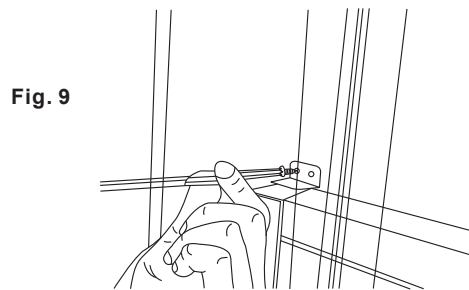

Fig. 9

D. Cut Window sash seal foam and insert it in the space between the upper and lower sashes (Fig. 10).

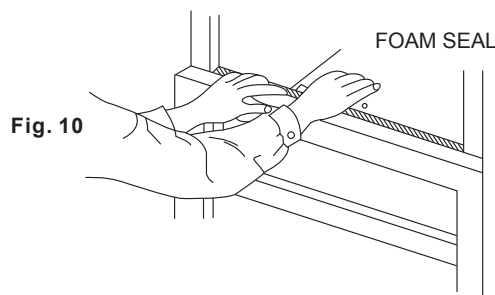

Fig. 10

If AC is Blocked by Storm Window

Add wood as shown in Fig. 11, or remove storm window before air conditioner is installed.

If storm window frame must remain, be sure the drain holes or slots are not caulked or painted shut. Accumulated rain water or condensation must be allowed to drain out.

Removing AC From Window

- Turn AC off, and disconnect power cord.
- Remove sash seal from between windows, and unscrew safety sash lock.
- Remove screws installed through frame and frame-lock.
- Keeping a firm grip on air conditioner, raise sash and carefully remove.
- Be careful not to spill any remaining water while lifting unit from window. Store parts WITH air conditioner.

Fig. 11

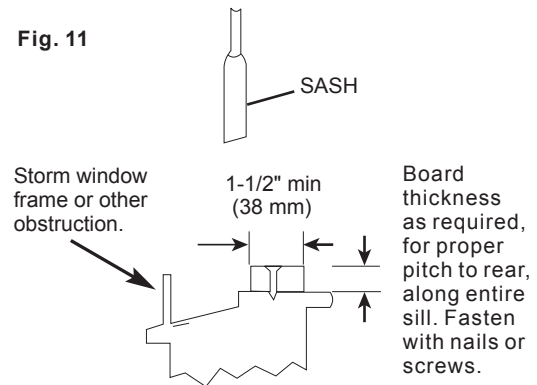

NORMAL SOUNDS

High Pitched Chatter

High efficiency compressors may have a high pitched chatter during the cooling cycle.

Vibration

Unit may vibrate and make noise because of poor wall or window construction or incorrect installation. This DOES NOT indicate a defective unit.

Pinging or Switching

Droplets of water hitting condenser during normal operation may cause "pinging" or "switching" sounds.

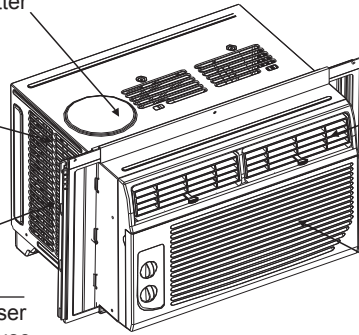

Sound of Rushing Air

At the front of the unit, the sound of rushing air being moved by the fan may be heard.

Gurgle/Hiss

"Gurgling" or "hissing" noise may be heard due to refrigerant passing through evaporator during normal operation.

NOTE: All of the pictures in this manual are for explanatory purposes only. The actual shape/look of the air conditioner purchased may be slightly different, but the operations and functions are similar.

AIR CONDITIONER FEATURES



To reduce the risk of fire, electric shock, or injury to persons, read the IMPORTANT SAFETY INSTRUCTIONS before operating this appliance.

NOTE:

Always wait 3 minutes when turning unit off and then on again, and when changing from cool to fan and then back to cool. The cool circuit has an automatic 3 minute time delayed start if the unit is turned off and on quickly or is switched between cool and fan quickly. This allows pressure inside of the compressor to equalize and prevents overheating as well as possible circuit breaker tripping. Failure to follow these instructions may be harmful to your unit.

To begin operating the air conditioner, follow these steps:

1. Set the thermostat to the highest number (coldest or cooler setting).
2. Set the selector control to the highest COOL setting.
3. Adjust the louver for comfortable air flow. (See "Air Directional Louvers" below.)
4. Once the room has cooled, adjust the thermostat to the setting you find most comfortable.
5. Make sure that the air flow inside and outside are not obstructed by anything.

Air Directional Louvers

The louvers will allow you to direct the air flow Up or Down (on some models) and Left or Right throughout the room as needed. Pivot horizontal louvers until the desired Up/Down direction is obtained. Move the Lever(s) from side to side until the desired Left/Right direction is obtained.

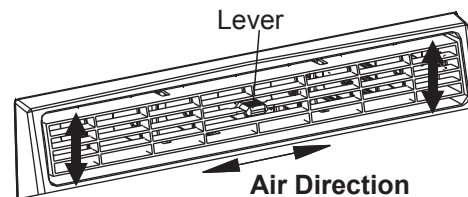
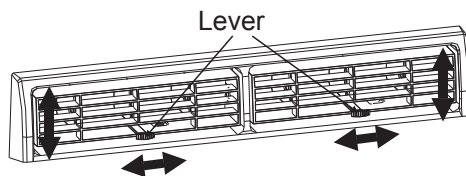

AIR CONDITIONER FEATURES (Continued)

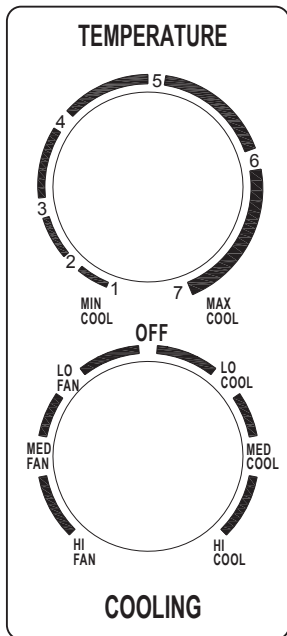

TEMPERATURE

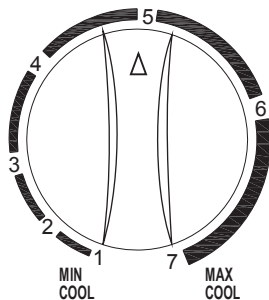

NOTE: The controls featured in this manual are representative of many available models. Your model may offer slightly different features.

COOL MODE

The desired cool setting is selected by rotating the "COOLING" knob to the right to the appropriate location.

HI COOL has maximum cooling effect and airflow.

LO COOL has a minimum cooling effect and airflow.

MED COOL has an intermediate cooling effect and airflow.

OFF will completely shut off the unit.

FAN MODE

Rotate the "COOLING" knob to the left to select your choice of fan speeds for air circulation.

NOTE: When selecting a fan speed, the compressor will not run.

THERMOSTAT

The thermostat ("TEMPERATURE" knob) is used to set the desired room temperature when the unit is being operated in the COOL MODE.

To set the desired room temperature, rotate the top knob ("TEMPERATURE") to the desired setting. After the set temperature is achieved, the thermostat will automatically start and stop the compressor in order to maintain the desired set temperature.

Rotate the thermostat selector ("TEMPERATURE" knob) clockwise for higher cool settings. Higher cool settings will provide lower room temperature.

Rotate the thermostat selector ("TEMPERATURE" knob) counter clockwise for lower cool settings. Lower cool settings will provide higher room temperature.

CARE AND CLEANING

CAUTION

Clean air conditioner occasionally to keep it looking and operating like new. **Be sure to unplug the unit before cleaning to prevent shock or fire hazards.**

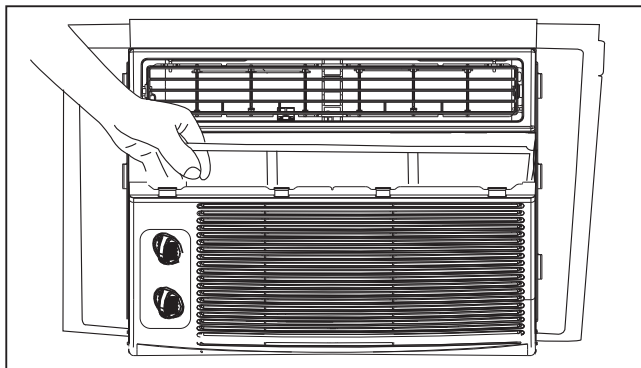

AIR FILTER CLEANING

The air filter should be checked at least every two weeks or as necessary. Trapped particles in the filter can build up and cause an accumulation of frost on the cooling coils.

- Place one hand on each side of the unit and tilt-open the front panel.
- Take the filter by the center and pull it up.
- Wash the filter using liquid dishwashing detergent and warm water. Rinse filter thoroughly.
- Gently shake excess water from the filter. Be sure the filter is thoroughly dry before replacing.
- As an alternative, vacuum the filter clean.

NOTES:

- Never use hot water over 104°F (40°C) to clean the air filter.
- Never attempt to operate the unit without the air filter.

CABINET CLEANING

- Be sure to unplug the air conditioner to prevent shock or fire hazard. The cabinet and front may be dusted with an oil-free cloth or with a cloth dampened in a solution of warm water and mild liquid dishwashing detergent. Rinse thoroughly and wipe dry.
- Never use harsh cleaners, wax or polish on the cabinet front.
- Be sure to wring excess water from the cloth before wiping the controls. Excess water in or around the controls may cause damage to the air conditioner.
- Plug in air conditioner after unit has dried completely.

WINTER STORAGE

If air conditioner will be stored in the winter, remove it carefully from the window according to the installation instructions. Cover it with plastic or return it to the original carton.

Always store unit in upright position.

TROUBLESHOOTING TIPS

Before calling for service, please review the chart below.

Issue	Possible Solutions
<p>AIR CONDITIONER NOT COOLING ROOM, OR NOT BLOWING COLD AIR</p>	<ul style="list-style-type: none"> • Be sure unit is not too large or too small for the area of the room. • Verify that all doors, windows, curtains and any other openings are closed off. Verify nothing is obstructing the front grille of unit, such as curtains, etc. • Allow enough time for room to cool, especially if outside temp is very high. • Check that the filter is not dirty and louvers are open all the way and blowing in the direction desired. • Check that unit is set to Cool Mode and that temperature is down enough (but not too low). • If unit is near a heat source, such as a stove, etc., then relocate unit. • If air coming from unit is cool to the touch, then unit is working properly; please double check the first three bullet points above. • If using Follow Me remote feature, move remote away from unit. • Temperature sensor behind air filter touching cold coil. These two elements should not be touching. Carefully straighten tube away from coil. • Unplug unit for at least 5 minutes. Follow Reset instructions on plug.
<p>AIR CONDITIONER COOLING BUT ROOM IS TOO WARM - ICE FORMING ON COOLING COIL BEHIND DECORATIVE FRONT</p>	<ul style="list-style-type: none"> • Outdoor temperature is below 64°F (18°C). To defrost the coil, set to Fan Only mode. • Air filter may be dirty. Clean filter. Refer to Care and Cleaning section. To defrost, set to Fan Only mode. • Thermostat is set too cold for night-time cooling. To defrost the coil, set to Fan Only mode. Then, set temperature to a higher setting.
<p>AIR CONDITIONER CYCLING ON AND OFF TOO FREQUENTLY OR NOT ENOUGH</p>	<ul style="list-style-type: none"> • Be sure unit is not too large or too small for the area of the room. • Remove grille and make sure the temperature sensor is not too close to the coils. These two elements should not be touching. Carefully straighten tube away from coil. • Make sure nothing is blocking the grille or side vents. • Make sure there is no dirt or debris inside the unit or on the filter.
<p>UNIT WILL NOT TURN ON</p>	<ul style="list-style-type: none"> • Reset circuit breaker. Make sure there are not too many items (ie lamps, TV's, etc.) working off the same breaker. • Check plug connection. • If plug is operating on an on/off switch, be sure that the switch is 'on'. • Try plugging unit into another outlet. • Unplug unit for at least 5 minutes. Follow Reset instructions on plug.
<p>UNIT BLOWS FUSES OR POPS CIRCUIT BREAKER</p>	<ul style="list-style-type: none"> • Make sure there are enough available amps on the circuit for the air conditioner. • Large units which run on a 230v will require a dedicated 20 or 30 amp circuit.
<p>AIR CONDITIONER IS MAKING NOISES</p>	<ul style="list-style-type: none"> • Check to be sure the unit is free from debris such as leaves, sticks, etc. Verify nothing is obstructing the unit. • Check the fan blade for cracks or chips. • Make sure the unit is properly and securely mounted inside the window or wall. • Clean the air filter.
<p>WATER PUDDLES INSIDE UNIT OR IS COMING INTO ROOM</p>	<ul style="list-style-type: none"> • Adjust the slope of the unit so that it drains downward toward the exterior of the home. (See Installation Instructions.) • Make sure that there is no debris blocking the drainage area of the unit.
<p>WATER DRIPPING OUTSIDE</p>	<ul style="list-style-type: none"> • Unit is removing a large quantity of moisture from a humid room. This is normal during excessively humid days.
<p>REMOTE SENSING / FOLLOW ME DEACTIVATING PREMATURELY</p>	<ul style="list-style-type: none"> • Remote control not located within range. Place remote control within 20 ft and 180° radius of the front of the unit. • Remote control signal obstructed. Remove obstruction.

NOTE: A highly recommended troubleshoot for any issue in general consists of turning off unit and unplugging for 5 minutes. It is also recommended to try another wall outlet.



COMFORT...BUILT TO LAST

Distributed by:

Perfect Aire, LLC
5151 Belt Line Rd.
Suite 878
Dallas, TX 75254

877-365-6274
www.perfectaire.us

Specification and performance data is subject to change without notice.

Printed in China